

Deluge Valve

Fig. 502

Description

Deluge Valve is known as a system control valve in a deluge system, used for fast application of water in a spray system. Deluge valve protects areas such as power transformer installation, storage tank, conveyor protection and other industrial application etc. With the addition of foaming agent, deluge valve can be used to protect aircraft hanger and inflammable liquid fire.

Valve Operation

Fig. 502 Deluge Valve is a quick release, hydraulically operated diaphragm valve. It has three chambers, isolated from each other by the diaphragm operated clapper and seat seal. While in SET position, water pressure is transmitted through an external bypass check valve and restriction orifice from the system supply side to the top chamber, so that supply pressure in the top chamber act across the diaphragm operated clapper which holds the seat against the inlet supply pressure, because of the differential pressure design. On detection of fire, the top chamber is vented to atmosphere through the outlet port via opened actuation devices. The top chamber pressure cannot be replenished through the restricted inlet port, and the upward force of the supply pressure lifts the clapper allowing the water flow to the system piping network and alarm devices.



Groove Pipe Size

Nominal Size	Pipe OD in mm
DN 50 (2")	60.3
DN 80 (3")	89
DN 100 (4")	114.3
DN 150 (6")	165.1
DN 150 (6")	168.3
DN 200 (8")	219.1

Note: For DN 150 (6") Standard Supply is 168.3 mm OD groove pipe.
For 165.1 mm Specify on order

Technical Details

Model	Fig 502 - Ductile Iron ASTM A 536-77 Grade 65-45-12		
Nominal Size	DN 50, 80, 100, 150, 200		
Working Pressure	1.4 to 17.5 bar (20 to 250 psi)		
End Connection	Flange x Flange, Groove x Groove		
Threaded Opening	BSPT		
Mounting	Vertical or Horizontal		
Hydrostatic Body Test Pressure	34.5 bar (500 psi)		
Flange Connection	ANSI B 16.5 #150 FF (RF-Optional)		
Wet Pilot Sprinkler Height Limitation	As per graph in the catalogue		
Net Weight Without Trim		FxF	GxG
	DN 50	- 32kg	27kg
	DN 80	- 35kg	29kg
	DN 100	- 50kg	42kg
	DN 150	- 79kg	68kg
DN 200	- 153kg	143kg	
Finish	Red RAL 3001		
Approval	UL Listed		
Ordering Information	1. Size of valve 2. Flange Specification, or for Groove end specify pipe OD 3. Valve trim vertical or horizontal 4. Trim type		



Deluge Valve

Fig. 502

Trim Description

The trims are functionally termed as Dry Pilot Trim, Wet Pilot Trim, Electric Trim and Test and Alarm Trim as per the method of actuation of the deluge valve.

The functionality of these trims is described below.

a) Dry Pilot Trim (Pneumatic Release)

Dry pilot operation uses a pilot line of closed Sprinkles/QB detectors containing air under pressure, located in the area to be protected. It requires regulated dry air supply with main supply point through restricted orifice. The air pressure to be maintained as specified in the catalogue of Dry Pilot Actuator. The pilot line is connected to air inlet side of actuator. The top chamber of the deluge valve is connected to water inlet side of actuator.

When there is an air pressure drop, or due to release of any of the release device on detection of re, the diaphragm of actuator is lifted and allows the water to drain. This releases the water pressure in the top chamber of the deluge valve, allowing the deluge valve to open and water to flow into the system piping & alarm devices.

Recommended air supply pressure for dry pilot trim system is 3.5 kg/sq.cm.

User must install non return valve at air supply connection to deluge valve trim.

In dry pilot trim, an actuator (DPA) is provided. An optional Pneumatic Reset Device (PRD) can be provided, which acts as a manual reset device in the dry pilot line.

b) Wet Pilot Trim (Hydraulic Release)

Wet pilot operation uses a pilot line of closed Sprinklers/QB detectors containing pressurized water, supplied through the upstream side of the Deluge valve, through a restricted orifice. All the release lines are connected to a common release line. Due to release of any one of the release device, the water pressure in the top chamber of the Deluge valve drops and the Deluge valve opens.

c) Electric Release Trim

To actuate a Deluge valve electrically, a solenoid valve is provided to drain the water from the top chamber of the Deluge valve. A pressure switch is provided to activate an electric alarm, to shut down the desired equipment or to give "Tripped" indication of the Deluge valve. In addition to this a pressure switch can also monitor "Low air pressure" and "Fire condition" when used in dry pilot air line.

d) Test And Alarm Trim

This trim is supplied with a test valve is provided to test the normal operation of the sprinkler alarm bell. The sprinkler alarm can be supplied additionally, which bells on actuation of the Deluge valve.

e) Drain And Drip Trim

This consists of main and system drain valve in addition with drip valve.

Trim Model	Trim Description	Mounting	Schematic No.
ETW	Basic Wet Pilot Trim	Vertical	Schematic 1
ETD	Basic Dry Pilot Trim	Vertical	Schematic 2
ETWT	Basic Wet Pilot Trim with Test & Alarm Trim	Vertical	Schematic 3
ETDT	Basic Dry Pilot with Test & Alarm Drain	Vertical	Schematic 4
ETWD	Basic Wet Pilot Trim with Drip & Drain Test	Vertical	Schematic 5
ETDD	Basic Dry Pilot Trim with Drip & Drain Test	Vertical	Schematic 6
NTW	Basic Wet Pilot Trim with Test & Alarm Trim and Drip & Drain Trim	Vertical	Schematic 7
NTD	Basic Dry Pilot Trim with Test & Alarm Trim and Drip & Drain Trim	Vertical	Schematic 8
ETW	Basic Wet Pilot Trim	Horizontal	Schematic 9
ETD	Basic Dry Pilot Trim	Horizontal	Schematic 10
ETWT	Basic Wet Pilot Trim with Test & Alarm Trim	Horizontal	Schematic 11
ETDT	Basic Dry Pilot Trim with Test & Alarm Trim	Horizontal	Schematic 12
ETWD	Basic Wet Pilot Trim with Drip & Drain Trim	Horizontal	Schematic 13
ETDD	Basic Dry Pilot Trim with Drip & Drain Trim	Horizontal	Schematic 14
NTW	Basic Wet Pilot Trim with Test & Alarm Trim and Drip & Drain Trim	Horizontal	Schematic 15
NTD	Basic Dry Pilot Trim with Test & Alarm Trim and Drip & Drain Trim	Horizontal	Schematic 16



Deluge Valve

Fig. 502

Trim Types

The trims are designated as following.

W =Wet Pilot trim. D = Dry Pilot Trim

a) Type ET-W and ET-D

This type of trim is basic trim required to operate the deluge valve. A solenoid valve for electric remote actuation and pressure switch for sensing & annunciation are optional.

b) Type ETW-D and ETD-D

This trim type is a combination of components of the ET trim along with the drip and drain trim. A solenoid valve for electric remote actuation and pressure switch for sensing & annunciation are optional.

c) Type ETW-T and ETD-T

This trim type is a combination of components of the ET trims along with the test and alarm trim. In dry pilot trim, an actuator DPA-H1 is provided with optional Pneumatic Reset Device (PRD-1). A solenoid valve for electric remote actuation and pressure switch for sensing & annunciation are optional.

d) Type NT-W and NT-D

This trim type is a combination of components of the ET trim along with the test and alarm trim as well as the drip and drain trim. A solenoid valve for electric remote actuation and pressure switch for sensing & annunciation are optional.

Resetting Procedure For The Deluge Valve

A. When Priming connection is below the upstream valve (Stop Valve)

- (i) Close the upstream side stop valve provided below the deluge valve to cease the flow of water.
- (ii) Open both the drain valves/ drain plugs and close when the flow of water has ceased.
- (iii) Close the release device/replace the Sprinkler if release was through Sprinkler/ QB Detector.
- (iv) Inspect and restore/ replace/ repair if required, the section of the detection system subjected to "Fire condition".
- (v) In case of dry pilot detection system, open the air supply valve to build-up air pressure. Open the priming valve fully. When top chamber pressure is more than 50% of the inlet pressure, open the upstream side of the stop valve provided below the Deluge valve. No water should flow into the system.
- (vi) When priming shut off valve (optional) is provided for resetting, then the water need to be drained from upstream side of valve.

B. When Priming connection is from the inlet of Deluge Valve (Auto resetting)

- (i) The deluge valve will reset automatically when release devices which were responsible for deluge valve opening are closed or restored back to their original status, (i.e closing of ERS or replacing the damaged Sprinkler if release was through Sprinkler/ QB Detector, or closing of Solenoid valve). The reset time may be long or cause vibration while closing, depending upon the system back pressure at the outlet of the valve.
- (ii) If priming shut of valve (optional) is provided, then the pressure in the priming shutoff valve is to be relieved by turning 3-way valve provided in the trim to reset deluge valve.

Caution

- (a) Do not close the priming valve, downstream and upstream stop valves, while system is in service.
- (b) The releasing device must be maintained in the open position, when actuated, to prevent the deluge valve from closure if anti shut off valve is not provided.
- (c) While using a deluge valve in the wet pilot system the height and the length of the wet pilot detection line is to be limited as shown in the wet pilot sprinkler height limitation graph.
- (d) Do not connect the Sprinkler Alarm outlet drain line to close a common drain as it may create back pressure & Sprinkler Alarm may not function.
- (e) Deluge valve must have support to absorb sudden opening or closing vibration shock to the piping.
- (f) To avoid water damage, take precautions when opening the water supply main control valve, since water will flow from all open system valves.
- (g) The responsibility of maintenance of the protection system and devices in proper operating condition lies with the owner of the system.
- (h) Deluge Valve & its trim shall be maintained at a minimum temperature of 40C. Heat tracing is not permitted.
- (i) Deluge Valve must be used in pressurised system.

System Testing Procedure

- (i) Keep the upstream side of the stop valve partially open. To avoid water flow to system side, close the system side stop valve. This valve is to be kept in open position after the testing is completed.
- (ii) Let any of the release devices to trip. This will result in a sudden drop of water pressure in the deluge valve top chamber which in turn will open the deluge valve. Close the upstream side stop valve immediately.
- (iii) Reset the valve as per the procedure given under heading "RESETTING PROCEDURE FOR THE DELUGE VALVE"

Deluge Valve

Fig. 502

Inspection And Maintenance

Installed system piping network must be flushed properly before placing the Deluge valve in service.

A qualified and trained person must commission the system. After few initial successful tests, an authorized person must be trained to perform inspection and testing of the system. It is recommended to have regular inspection and test run of the system as per NFPA guideline or in accordance to the organisation having local jurisdiction.

(i) Warning

Inspection and testing is to be carried out only by authorised and trained personnel. DO NOT TURN OFF the water supply or close any valve to make repair(s), or test the valve without placing a roving fire patrol in the area covered by the system. Also inform the local security personnel and central alarm station, so that there is no false alarm signal.

It is recommended to carry out physical inspection of the system at least twice in a week. The inspection should verify that all the control valves are in proper position as per the system requirement and that there are no damages to any component.

The frequency of inspections must be increased in the presence of contaminated water supplies, corrosive/scaling water supplies, and corrosive atmospheres.

(ii) Normal Condition

- (a) All main valves are open and are sealed with tamper proof seal
- (b) Drain valves must be kept closed
- (c) No leak or drip is detected from the drip valve
- (d) All the gauges except the system side water pressure gauge, should show the required pressure
- (e) There should be no leakage in the system

(iii) Normal Condition Test

- (a) The system should be checked for normal condition at least once in a week.
- (b) Test the sprinkler alarm bell or electric alarm by turning the alarm test valve to the test position. The alarm should sound. This test should be carried out at least once in a week
- (c) Depress the drip valve knob. Significant accumulation indicates a possible seat leakage
- (d) Conduct the water flow test as per the procedure of system testing at least once a month.

(iv) Periodic Check

Conduct the water flow test by actuating few of the release devices provided in the system. Clean all strainer(s) and priming line restriction. This test is to be carried out at least once in three months.

Abnormal Condition

(i) Alarm Fails to Sound

- (a) Check for any obstruction in the alarm test line, make certain that the sprinkler alarm is free to operate.
- (b) If an electric alarm is provided, check the electrical circuitry to the alarm.

(ii) False Trips

- (a) Check for clogging in priming line, restriction orifice check valve, priming valve & strainer.
- (b) Leakage in the release system.
- (c) The deluge air panel orifice clogged or low supply pressure.

(iii) Leakage through the Deluge Valve

- (a) Damaged deluge valve seat or obstruction on the seat face by foreign object.
- (b) Leakage in release system.
- (c) Partly clogged priming line restriction orifice check valve.
- (d) Low air pressure on release system line or leakage in release system.

Note:

1. UL Listing is valid only when Deluge Valve is installed with trim set as per trim drawing.
2. The trip time of deluge valve on-of device through detection network, will depend on volume of detection network. If the trip time of deluge valve is more, then it can be substantially reduced by installing check valve in branch of release line in the detection network. The check valve flow shall be towards releasing device.
3. The pneumatic system must have restricted orifice at air or gas supply point. The restriction nozzle are supplied with HD dry pilot actuation trim.
4. UL Listing is valid only when Listed Solenoid Valve provided for electric operation of the deluge valve is retained in the trim. If any other solenoid valve is used, the deluge valve trip time may be quite high or deluge valve may not trip.
5. The Pressure Gauges standard supply is 300 psi for water gauge for system pressure upto 175 psi. If system pressure is more than 175 psi, then order for 600 Psi water pressure gauges.

Deluge Valve Fig. 502

Deluge Valve Fig 502 Size DN 50 / 80 / 100 / 150 / 200

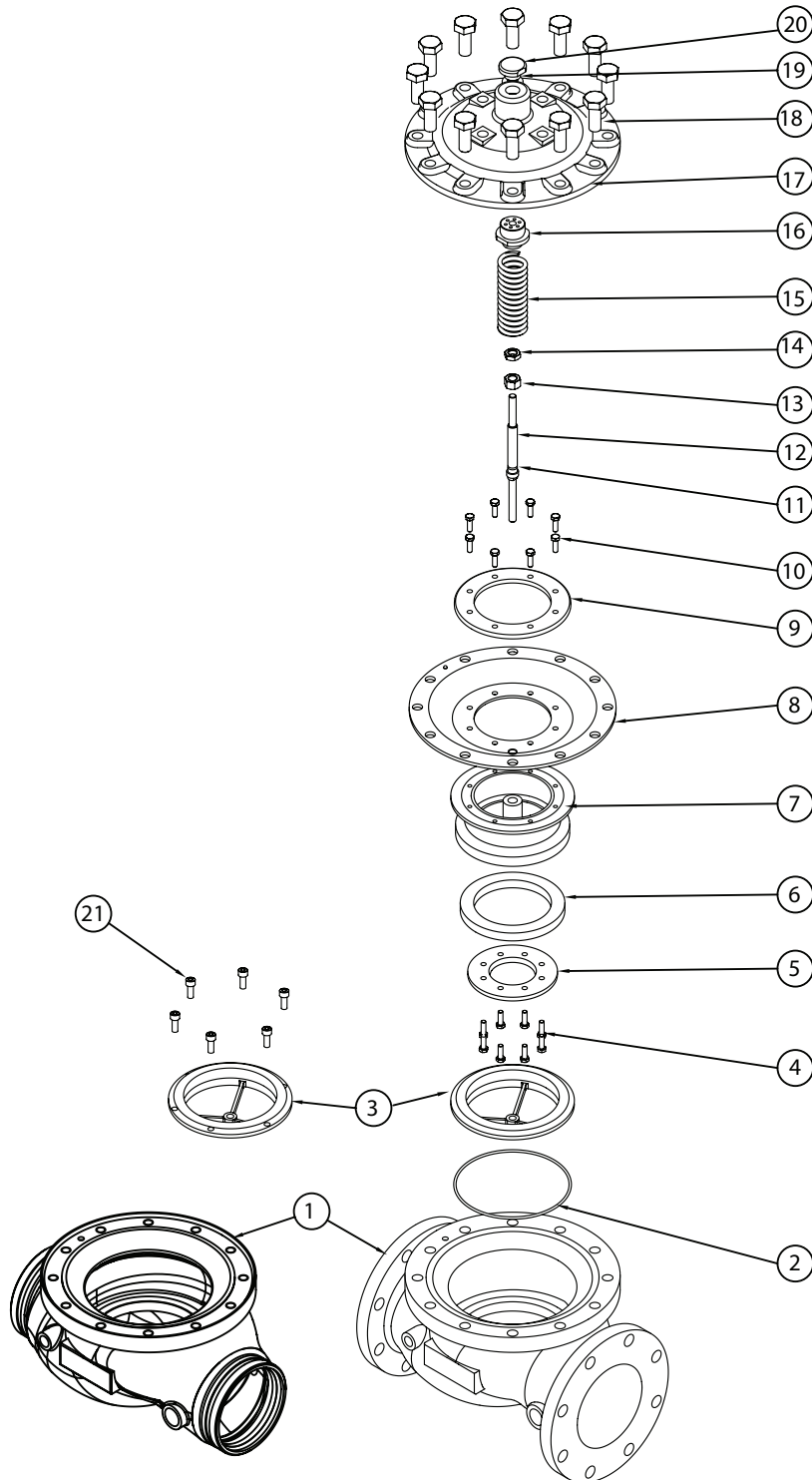

Groove X Groove

Flange to Flange

Deluge Valve Fig. 502

Deluge Valve Fig 502 Size DN 50 / 80 / 100 / 150 / 200

Dimensions (mm)

Valve Nominal Size	A		B
	F x F	G x G	
DN 50	320	350	232
DN 80	372	400	232
DN 100	412	440	245
DN 150	462	490	282
DN 200	552	580	332

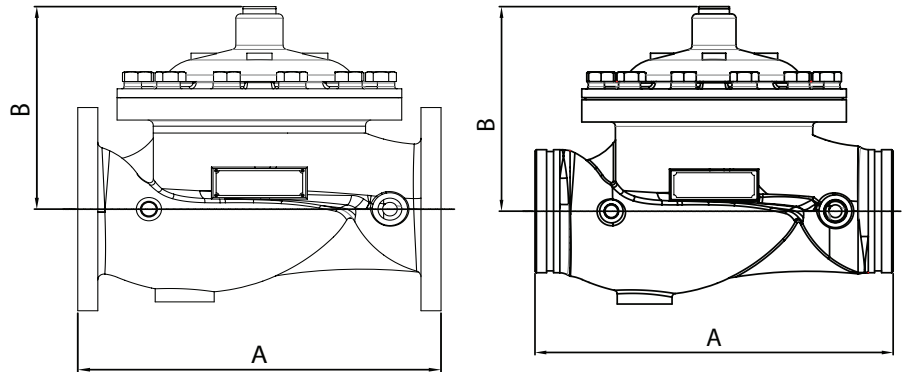

Part List

Item	Description	Qty.					Material Specification
		DN50	DN 80	DN 100	DN150	DN 200	
1	Housing	1	1	1	1	1	Ductile Iron
2	'O' Ring	1	1	1	1	1	Neoprene Rubber
3	Seat	1	1	1	1	1	Stainless Steel*
4	Bolt	-	-	4	4	8	Stainless Steel
5	Rubber Clamp	1	1	1	1	1	Ductile Iron**
6	Rubber Seat	1	1	1	1	1	Neoprene Rubber
7	Clapper	1	1	1	1	1	Ductile Iron**
8	Diaphragm	1	1	1	1	1	Neoprene Rubber
9	Clamp Ring	1	1	1	1	1	Ductile Iron**
10	Bolt	8	8	8	8	12	Stainless Steel
11	'O' Ring	1	1	1	1	1	Neoprene Rubber
12	Spindle	1	1	1	1	1	Stainless Steel
13	Nut	1	1	1	1	1	Stainless Steel
14	Lock Nut	1	1	1	1	1	Stainless Steel
15	Spring	1	1	1	1	1	Stainless Steel
16	Adaptor	1	1	1	1	1	Brass
17	Cover	1	1	1	1	1	Ductile Iron
18	Bolt	12	12	12	12	16	Carbon Steel
19	'O' Ring	1	1	1	1	1	Neoprene Rubber
20	Plug	1	1	1	1	1	Steel Plated
21	Allen Bolt	-	-	-	-	6	Stainless Steel

Note:

* Stainless Steel is standard supply, Bronze is optional supply.

** Ductile Iron is standard supply, Bronze/Stainless Steel is optional supply.

Deluge Valve
Fig. 502

Schematic For Wet Pilot Basic Trim For Deluge Valve Fig 502 For Vertical Mounting

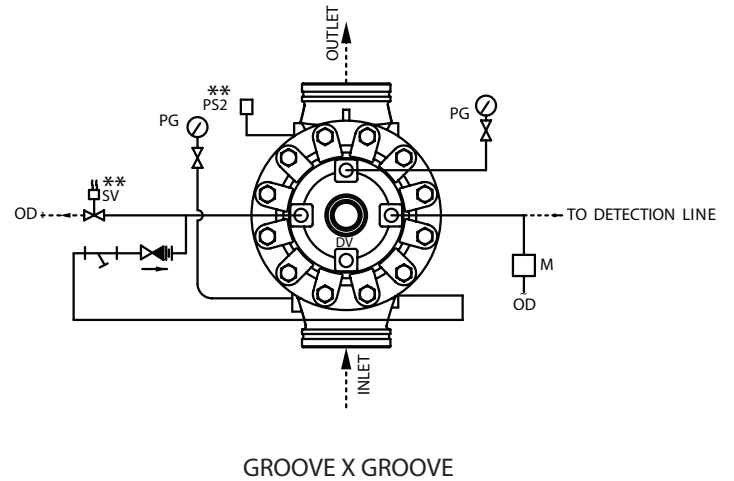
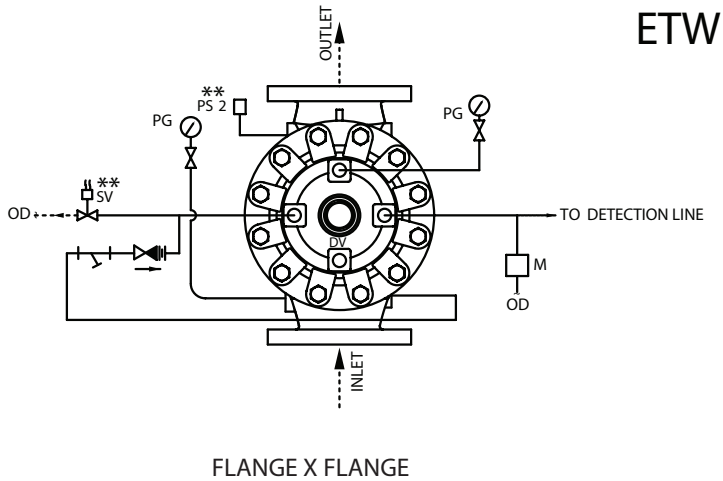

SCHMATIC 1

Schematic For Dry Pilot Basic Trim For Deluge Valve Fig 502 For Vertical Mounting

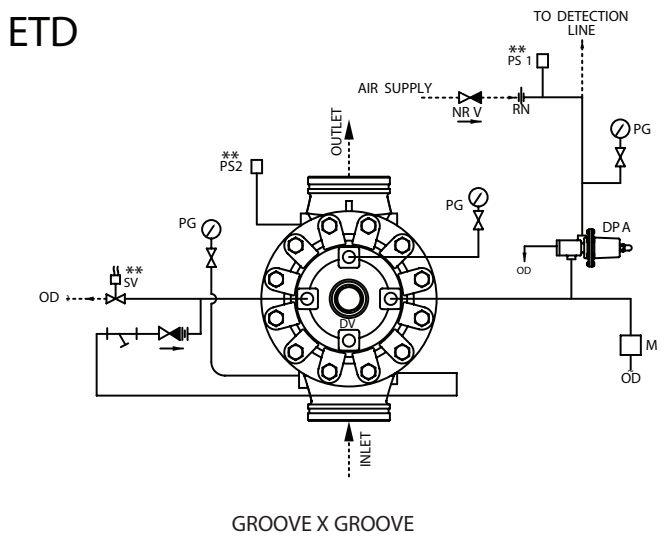
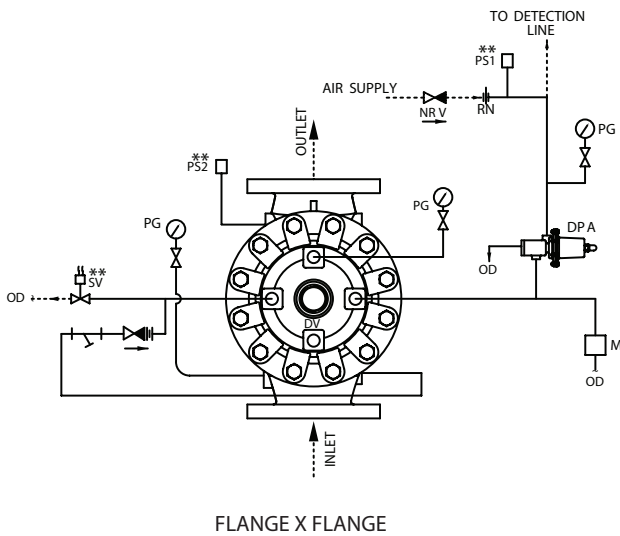

SCHMATIC 2

ABBREVIATION & SYMBOLS

DV	DELUGE VALVE
M	EMERGENCY RELEASE STATION
RN	RRESTRICTIOIN NOZZLE (AIR LINE)
SV	SOLENOID VALVE
PS1	LOW AIR ALARM PRESSURE SWITCH
PS2	WATER FLOW PRESSURE ALARM SWITCH

G	SPRINKLER ALARM (WMG)
PG	PRESSURE GAUGE
OD	OPEN DRAIN
DPA	DRY PILOT ACTUATOR
NRV	NON RETURN VALVE
**	OPTIONAL

	NRV WITH RESTRICTION HEX NIPPLE
	VALVE
	STRAINER
---	BY USER

Deluge Valve Fig. 502

Schematic For Wet Pilot Basic Trim For Deluge Valve Fig 502 For Vertical Mounting

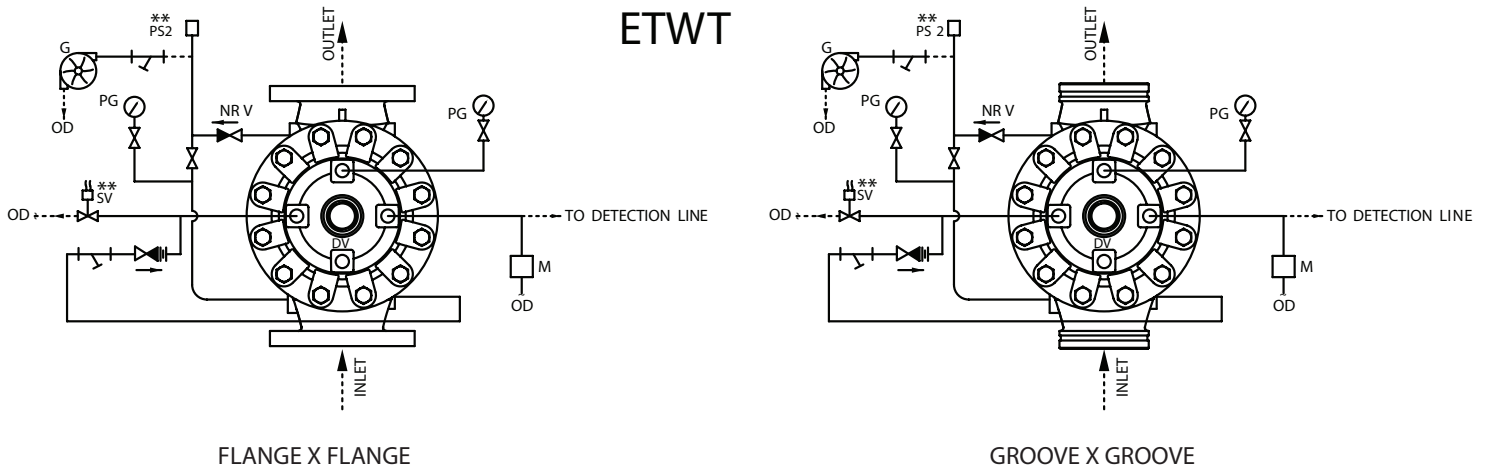

SCHEMATIC 3

Schematic For Dry Pilot Basic Trim For Deluge Valve Fig 502 For Vertical Mounting

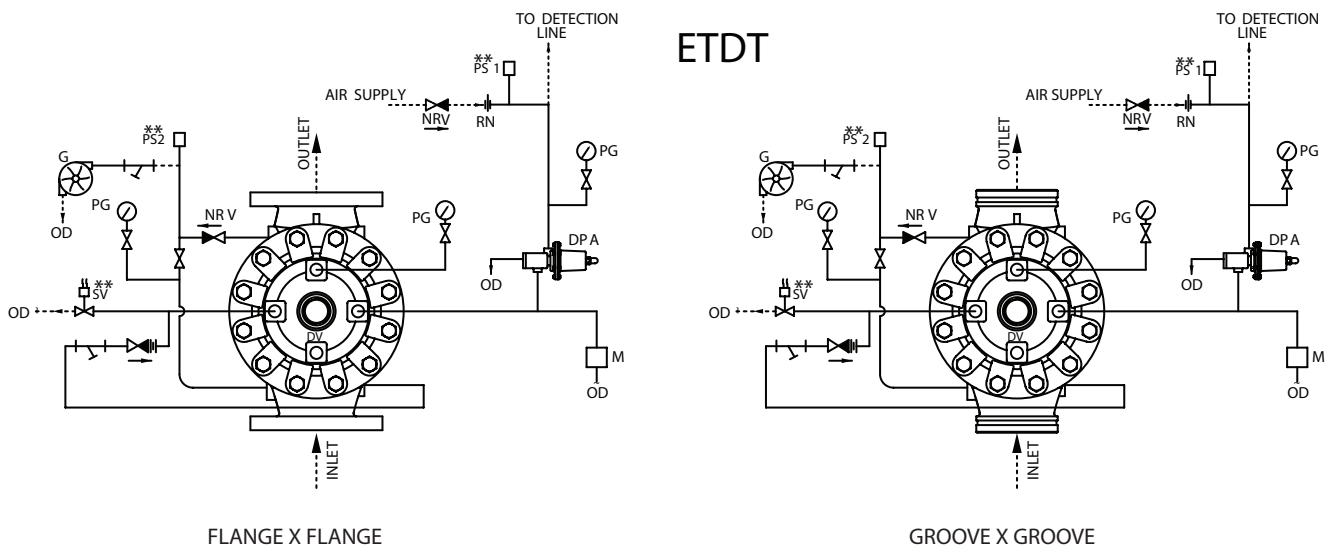

SCHEMATIC 4

ABBREVIATION & SYMBOLS

DV	DELUGE VALVE	G	SPRINKLER ALARM (WMG)		NRV WITH RESTRICTION HEX NIPPLE
M	EMERGENCY RELEASE STATION	PG	PRESSURE GAUGE		VALVE
RN	RRESTRICTION NOZZLE (AIR LINE)	OD	OPEN DRAIN		STRAINER
SV	SOLENOID VALVE	DPA	DRY PILOT ACTUATOR	---	BY USER
PS1	LOW AIR ALARM PRESSURE SWITCH	NRV	NON RETURN VALVE		
PS2	WATER FLOW PRESSURE ALARM SWITCH	**	OPTIONAL		

Deluge Valve
Fig. 502

Schematic For Wet Pilot Basic Trim For Deluge Valve Fig 502 For Vertical Mounting

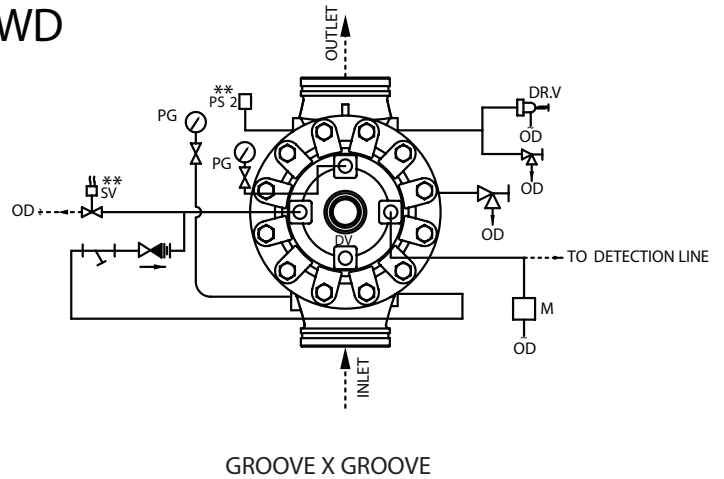
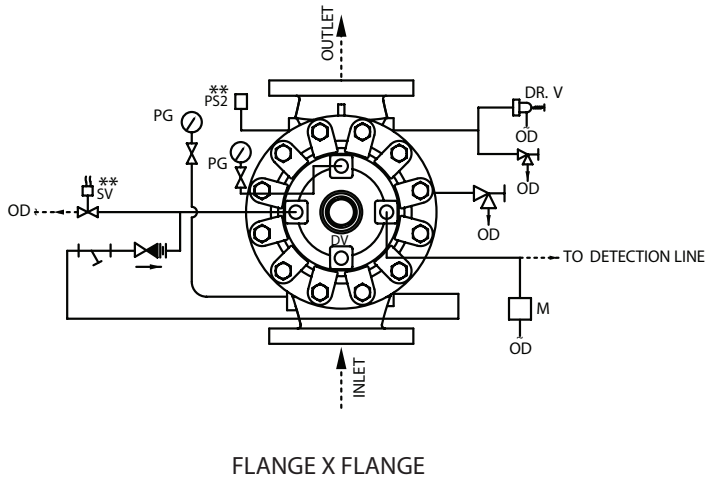

SCHEMATIC 5

Schematic For Dry Pilot Basic Trim For Deluge Valve Fig 502 For Vertical Mounting

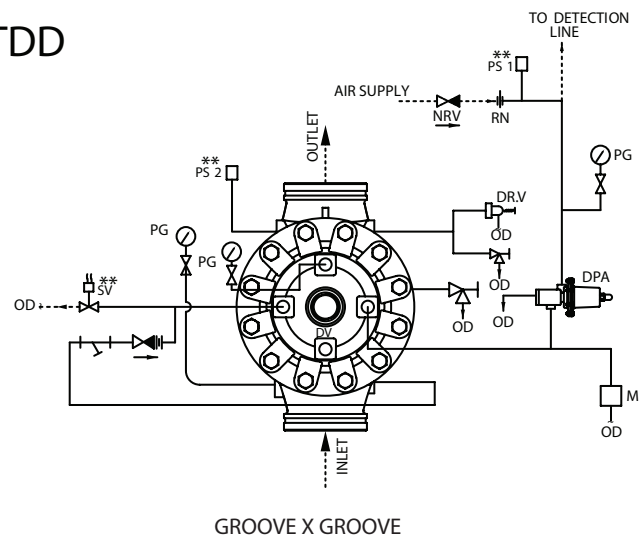
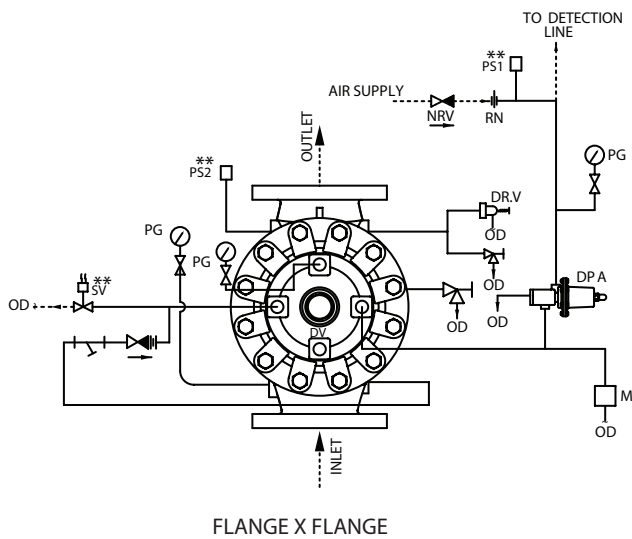

SCHEMATIC 6

ABBREVIATION & SYMBOLS

DV	DELUGE VALVE	G	SPRINKLER ALARM (WMG)		NRV WITH RESTRICTION HEX NIPPLE
M	EMERGENCY RELEASE STATION	PG	PRESSURE GAUGE		VALVE
RN	RRESTRICTION NOZZLE (AIR LINE)	OD	OPEN DRAIN		STRAINER
SV	SOLENOID VALVE	DPA	DRY PILOT ACTUATOR		ANGLE VALVE
PS1	LOW AIR ALARM PRESSURE SWITCH	DR.V	DRIIP VALVE	---	BY USER
PS2	WATER FLOW PRESSURE ALARM SWITCH	NRV	NON RETURN VALVE	**	OPTIONAL

Deluge Valve Fig. 502

Schematic For Wet Pilot Basic Trim For Deluge Valve Fig 502 For Vertical Mounting

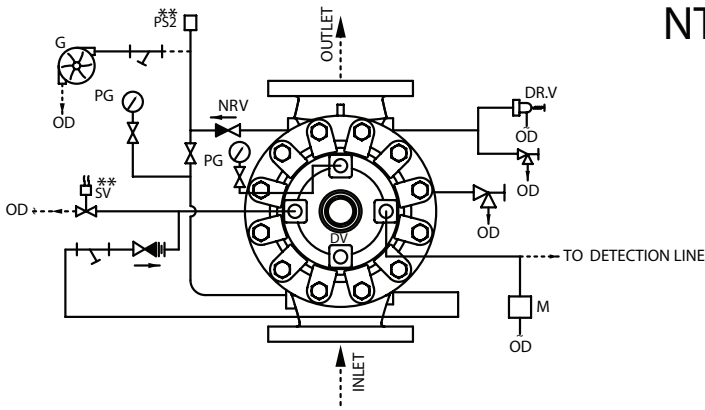

FLANGE X FLANGE

NTW

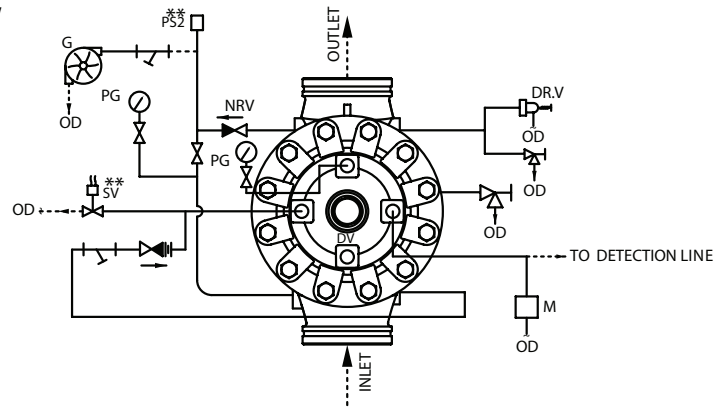

GROOVE X GROOVE

SCHEMATIC 7

Schematic For Dry Pilot Basic Trim For Deluge Valve Fig 502 For Vertical Mounting

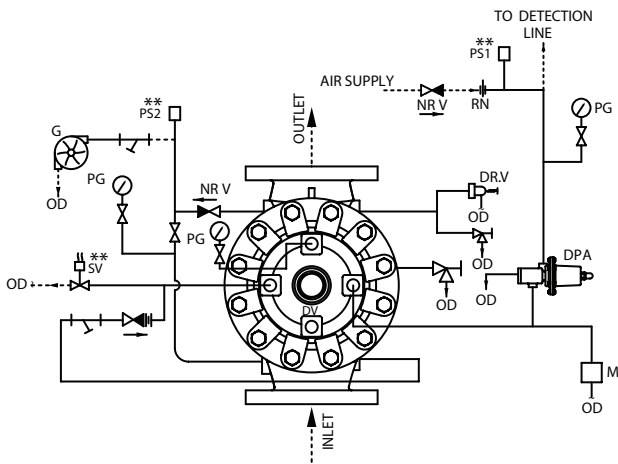

FLANGE X FLANGE

NTD

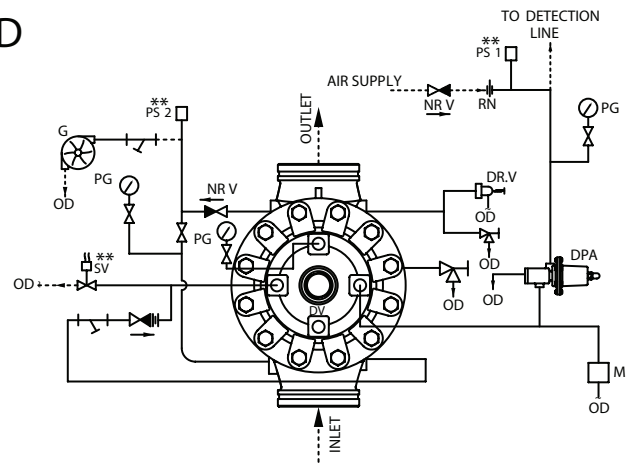

GROOVE X GROOVE

SCHEMATIC 8

ABBREVIATION & SYMBOLS

DV	DELUGE VALVE	G	SPRINKLER ALARM (WMG)		NRV WITH RESTRICTION HEX NIPPLE
M	EMERGENCY RELEASE STATION	PG	PRESSURE GAUGE		VALVE
RN	RRESTRICTION NOZZLE (AIR LINE)	OD	OPEN DRAIN		STRAINER
SV	SOLENOID VALVE	DPA	DRY PILOT ACTUATOR		ANGLE VALVE
PS1	LOW AIR ALARM PRESSURE SWITCH	DR.V	DRIP VALVE	---	BY USER
PS2	WATER FLOW PRESSURE ALARM SWITCH	NRV	NON RETURN VALVE	**	OPTIONAL

Deluge Valve
Fig. 502

Schematic For Wet Pilot Basic Trim For Deluge Valve Fig 502 For Horizontal Mounting

ETW

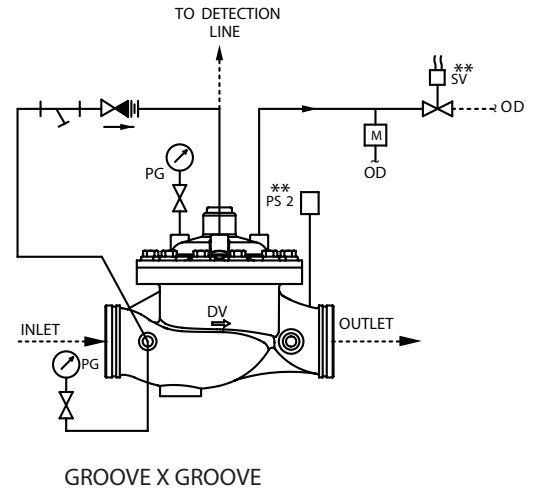
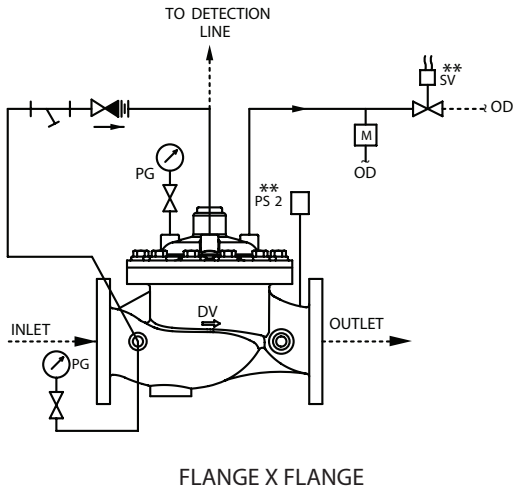

SCHEMATIC 9

Schematic For Dry Pilot Basic Trim For Deluge Valve Fig 502 For Horizontal Mounting

ETD

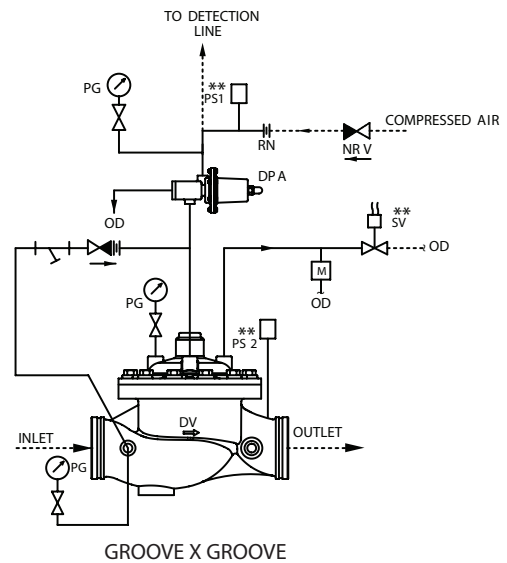
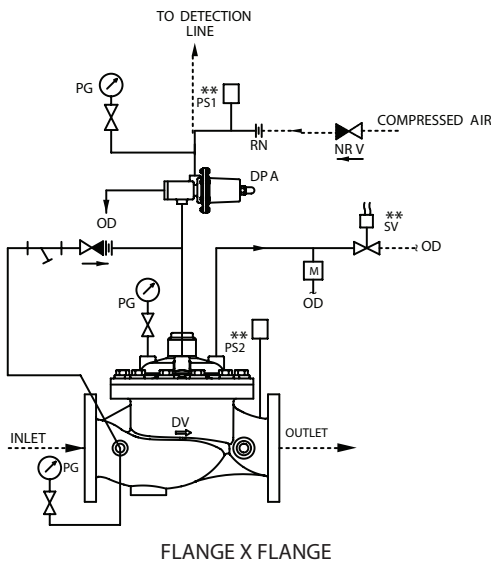

SCHEMATIC 10

ABBREVIATION & SYMBOLS

DV	DELUGE VALVE
M	EMERGENCY RELEASE STATION
RN	RESTRICTION NOZZLE (AIR LINE)
SV	SOLENOID VALVE
PS1	LOW AIR ALARM PRESSURE SWITCH
PS2	WATER FLOW PRESSURE ALARM SWITCH

G	SPRINKLER ALARM (WVG)
PG	PRESSURE GAUGE
OD	OPEN DRAIN
DPA	DRY PILOT ACTUATOR
NRV	NON RETURN VALVE
**	OPTIONAL

	NRV WITH RESTRICTION HEX NIPPLE
	VALVE
	STRAINER
	BY USER

Deluge Valve Fig. 502

Schematic For Wet Pilot Basic Trim For Deluge Valve Fig 502 For Horizontal Mounting

ETWT

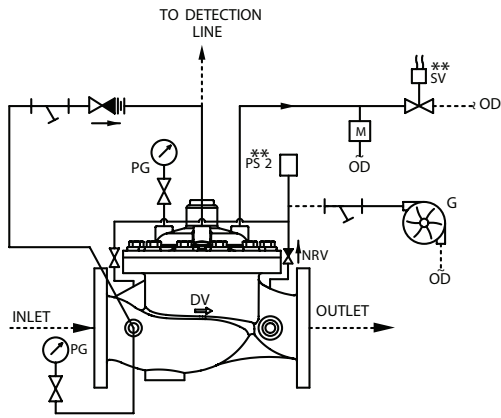

FLANGE X FLANGE

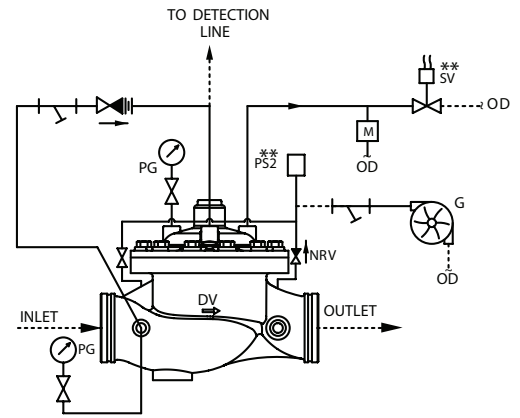

GROOVE X GROOVE

SCHEMATIC 11

Schematic For Dry Pilot Basic Trim For Deluge Valve Fig 502 For Horizontal Mounting

ETDT

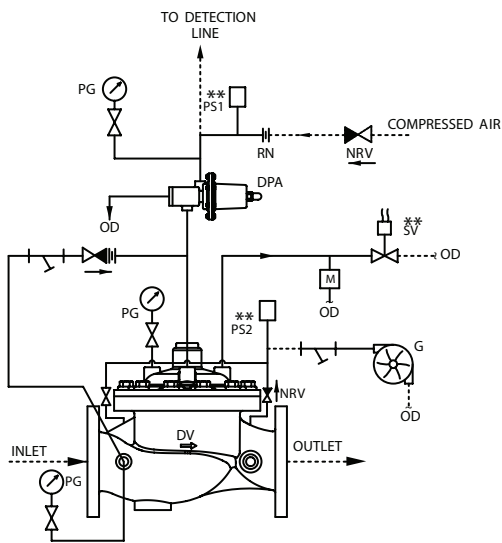

FLANGE X FLANGE

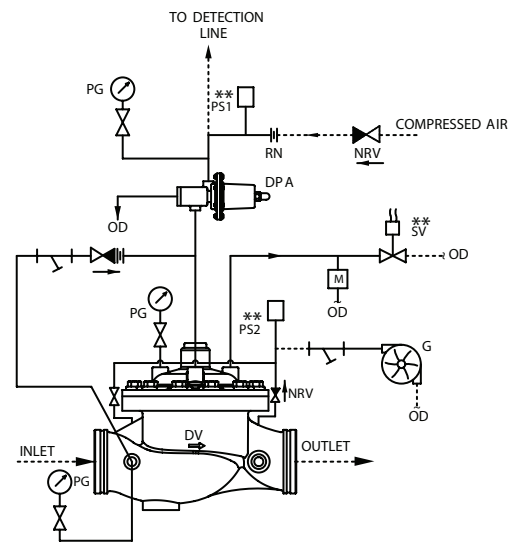

GROOVE X GROOVE

SCHEMATIC 12

ABBREVIATION & SYMBOLS

DV	DELUGE VALVE
M	EMERGENCY RELEASE STATION
RN	RRESTRICTIOIN NOZZLE (AIR LINE)
SV	SOLENOID VALVE
PS1	LOW AIR ALARM PRESSURE SWITCH
PS2	WATER FLOW PRESSURE ALARM SWITCH

G	SPRINKLER ALARM (WMG)
PG	PRESSURE GAUGE
OD	OPEN DRAIN
DPA	DRY PILOT ACTUATOR
NRV	NON RETURN VALVE
**	OPTIONAL

	NRV WITH RESTRICTION HEX NIPPLE
	VALVE
	STRAINER
--	BY USER

Deluge Valve
Fig. 502

Schematic For Wet Pilot Basic Trim For Deluge Valve Fig 502 For Horizontal Mounting

ETWD

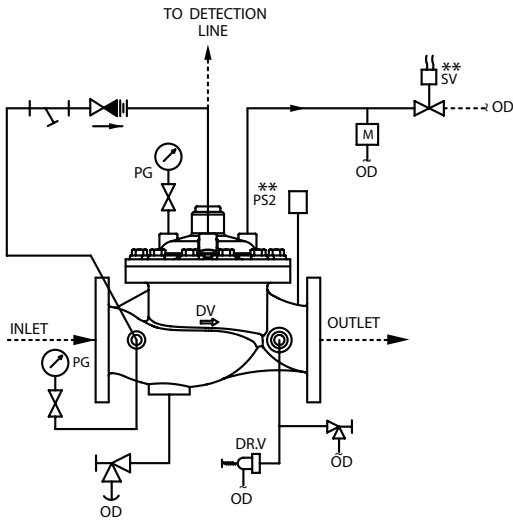

FLANGE X FLANGE

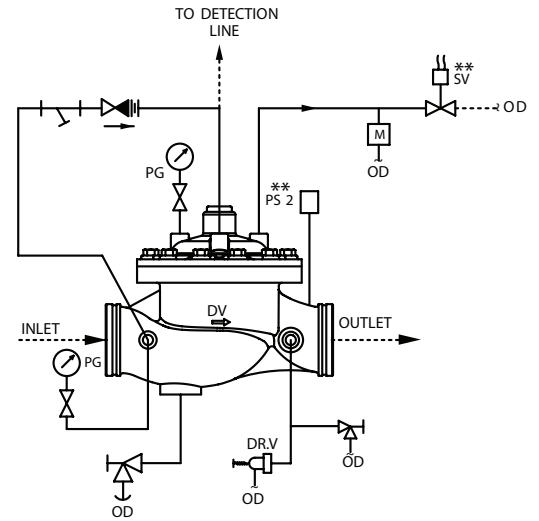

GROOVE X GROOVE

SCHEMATIC 13

Schematic For Dry Pilot Basic Trim For Deluge Valve Fig 502 For Horizontal Mounting

ETDD

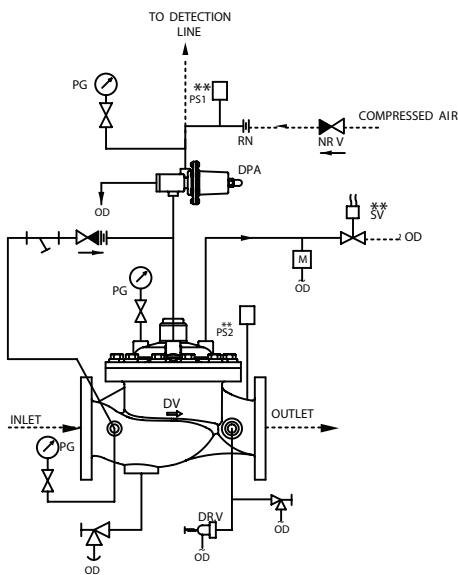

FLANGE X FLANGE

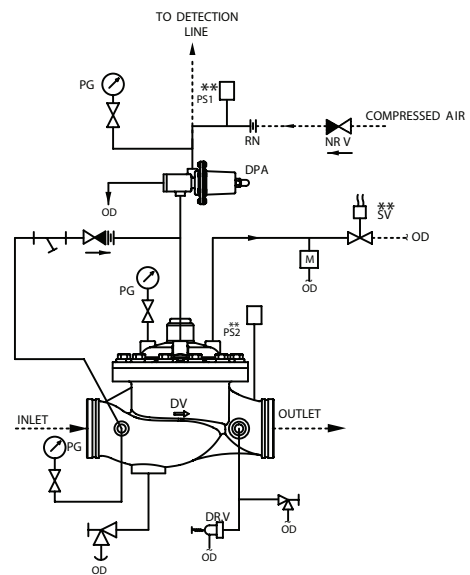

GROOVE X GROOVE

SCHEMATIC 14

ABBREVIATION & SYMBOLS

DV	DELUGE VALVE
M	EMERGENCY RELEASE STATION
RN	RRESTRICTION NOZZLE (AIR LINE)
SV	SOLENOID VALVE
PS1	LOW AIR ALARM PRESSURE SWITCH
PS2	WATER FLOW PRESSURE ALARM SWITCH

G	SPRINKLER ALARM (WMG)
PG	PRESSURE GAUGE
OD	OPEN DRAIN
DPA	DRY PILOT ACTUATOR
DR.V	DRIIP VALVE
NRV	NON RETURN VALVE

	NRV WITH RESTRICTION HEX NIPPLE
	VALVE
	STRAINER
	ANGLE VALVE
	BY USER
	OPTIONAL

Deluge Valve
Fig. 502

Schematic For Wet Pilot Basic Trim For Deluge Valve Fig 502 For Horizontal Mounting

NTW

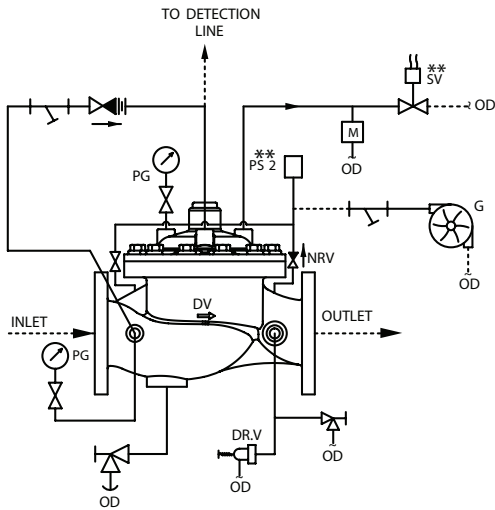

FLANGE X FLANGE

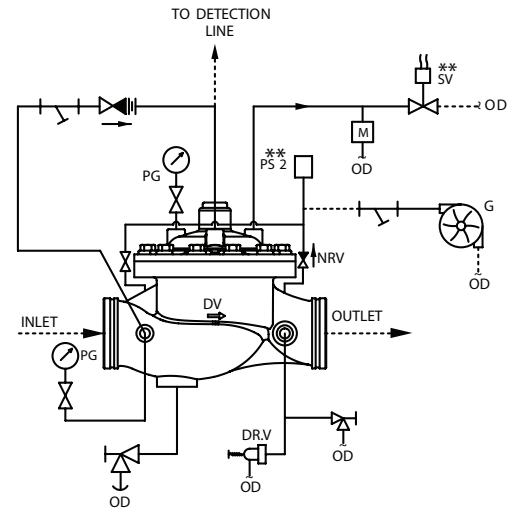

GROOVE X GROOVE

SCHEMATIC 15

Schematic For Dry Pilot Basic Trim For Deluge Valve Fig 502 For Horizontal Mounting

NTD

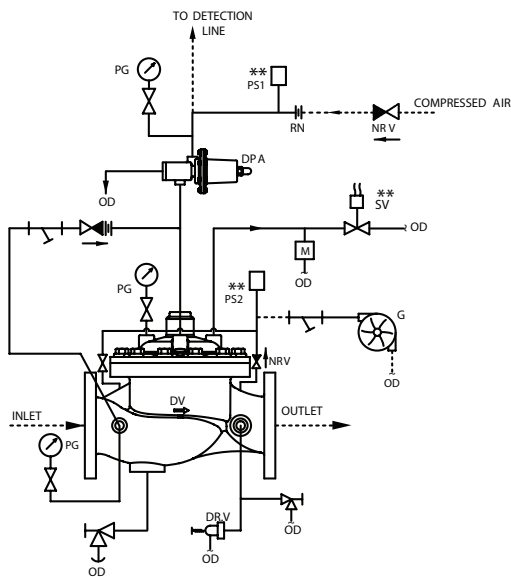

FLANGE X FLANGE

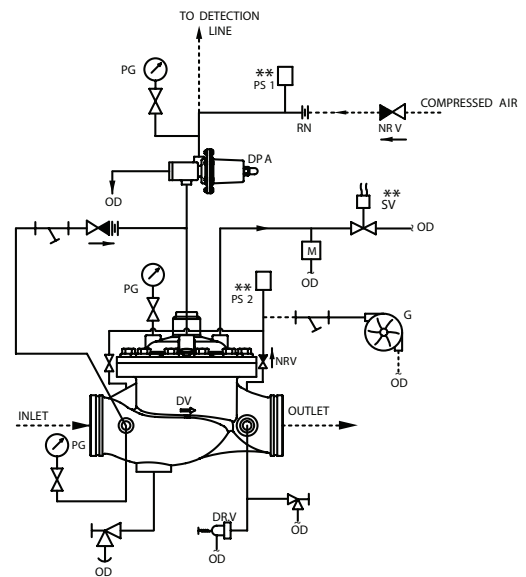

GROOVE X GROOVE

SCHEMATIC 16

ABBREVIATION & SYMBOLS

DV	DELUGE VALVE
M	EMERGENCY RELEASE STATION
RN	RRESTRICTIOIN NOZZLE (AIR LINE)
SV	SOLENOID VALVE
PS1	LOW AIR ALARM PRESSURE SWITCH
PS2	WATER FLOW PRESSURE ALARM SWITCH

G	SPRINKLER ALARM (WMG)
PG	PRESSURE GAUGE
OD	OPEN DRAIN
DPA	DRY PILOT ACTUATOR
DR.V	DRIIP VALVE
NRV	NON RETURN VALVE

	NRV WITH RESTRICTION HEX NIPPLE
	VALVE
	STRAINER
	ANGLE VALVE
	BY USER
**	OPTIONAL



Deluge Valve Fig. 502

Sprinkler Height Limitation

DV - DN 50

KG/SQCM

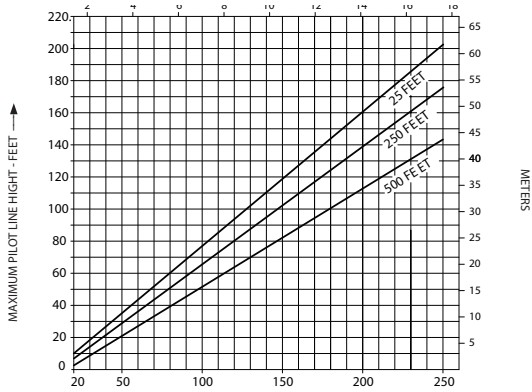

DV - DN 80

KG/SQCM

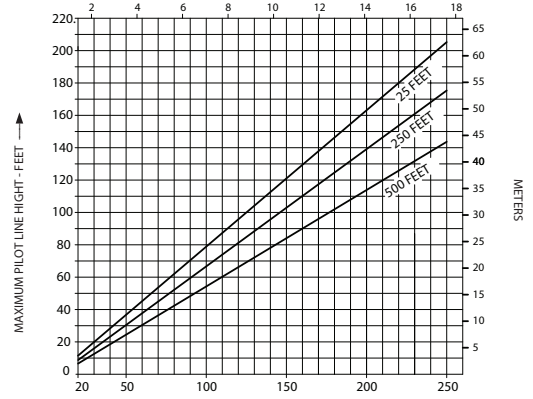

DV - DN 100

KG/SQCM

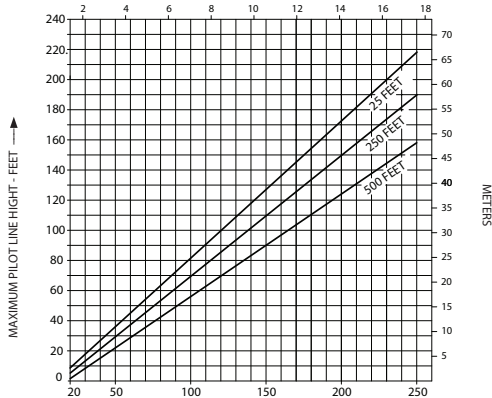

DV - DN150

KG/SQCM

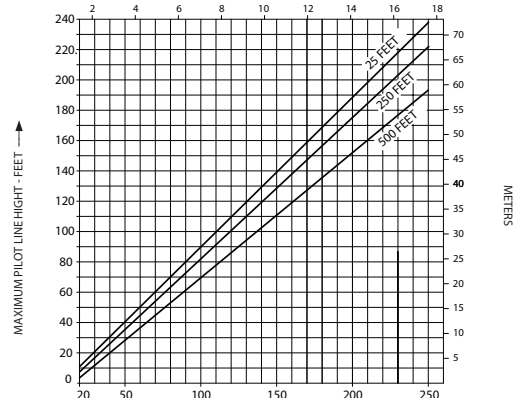

DV - DN 200

KG/SQCM

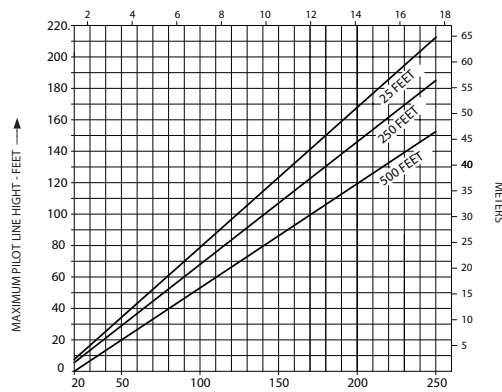

Deluge Valve
Fig. 502

Deluge Valve Fig 502

Nominal Pressure Loss vs Flow

(* Flow at 15 feet per second [4.57 meter per second])

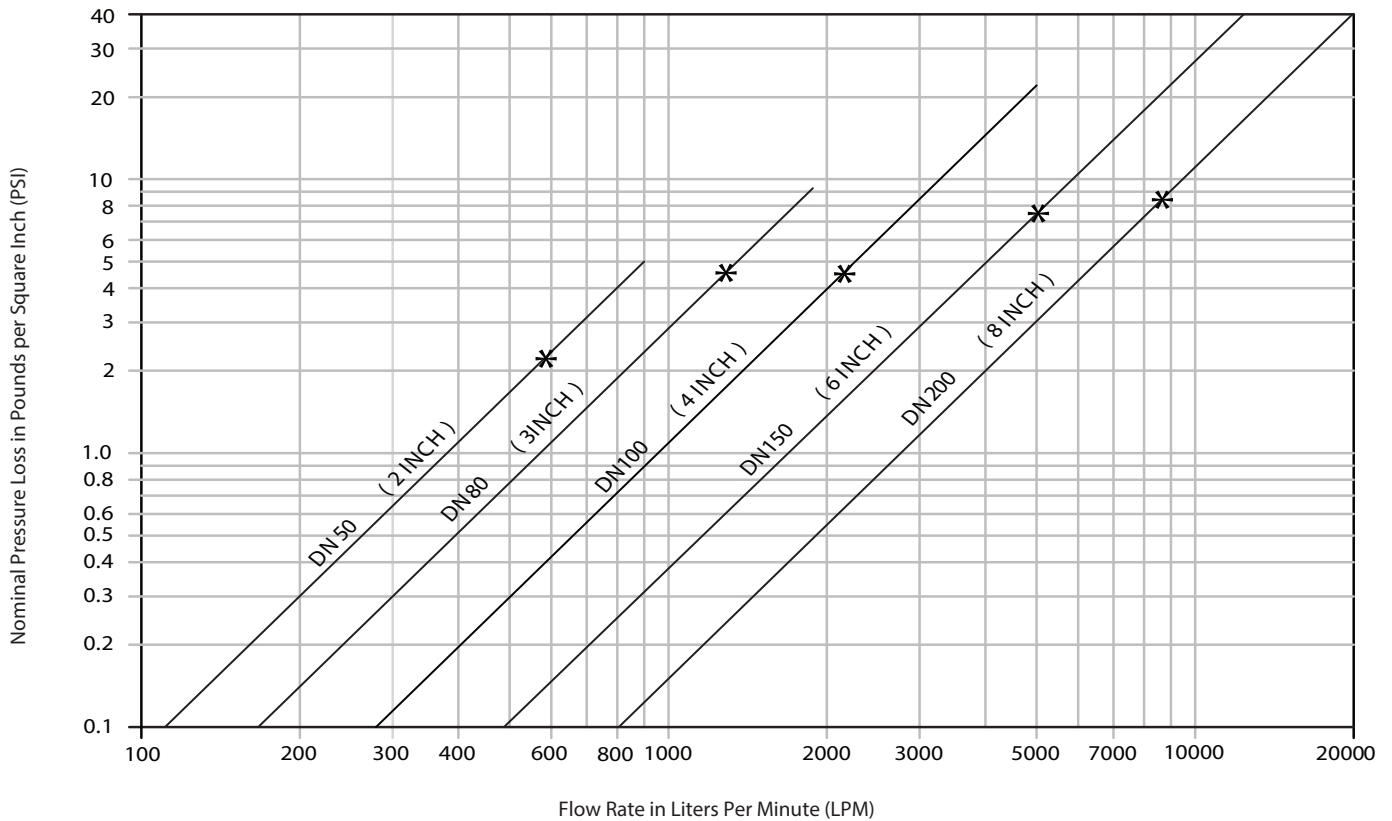

- * 2.3 PSI Pressure loss @ 15 feet per second (4.57 met/sec) velocity having flow of 594 LPM thru 50NB DV
- * 4.7 PSI Pressure loss @ 15 feet per second (4.57 met/sec) velocity having flow of 1308 LPM thru 80NB DV
- * 4.7 PSI Pressure loss @ 15 feet per second (4.57 met/sec) velocity having flow of 2255 LPM thru 100NB DV
- * 7.5 PSI Pressure loss @ 15 feet per second (4.57 met/sec) velocity having flow of 5117 LPM thru 150NB DV
- * 8.4 PSI Pressure loss @ 15 feet per second (4.57 met/sec) velocity having flow of 8854 LPM thru 200NB DV

NOTICE:

The equipment presented in this bulletin is to be installed in accordance with the latest publication standards of NFPA or other similar organisations also with the provision of government codes or ordinances where applicable. The information provided by us are to the best of our knowledge and belief, and are general guidelines only. Site handling and installation control is beyond our reach. Hence we give no guarantee for result and take no liability for damages, loss or penalties whatsoever, resulting from our suggestion, information, recommendation or damages due to our product. Product development is a continuous programme of Rapidrop and hence the right to modify any specification without prior notice is reserved with the company.